

Measuring colloidal forces with TIRM

Laurent Helden
Christopher Hertlein

2. Physikalisches Institut
Universität Stuttgart

- Messmethoden
- Total Internal Reflection Microscopy (TIRM)
- Experimental set-up
- Force resolution

Direct measurements of colloidal forces

problem: typical forces in the nN to fN range

▪ Surface force apparatus (SFA)

- J.N. Israelachvili, *Intermolecular and surface forces*, Academic Press (1991).

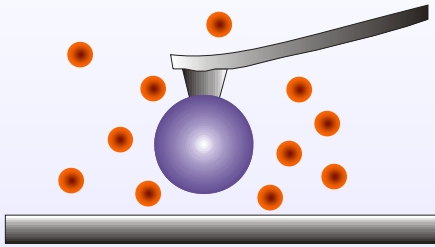
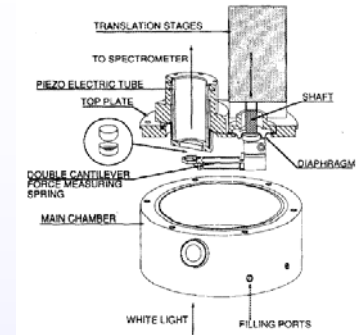

▪ Atomic force microscope (AFM)

- Ducker, Senden, Pashley, *Nature*, **353**, 239 (1991).
- Milling, Vincent, *J. Chem. Soc., Faraday Trans.* **93**, 3179 (1997).

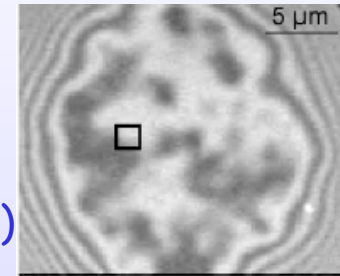

▪ Reflection Interference Contrast Microscopy (RICM)

- Rädler, Sackmann, *J. Phys. II France*, **3**, 727 (1993).
- Schilling, Sengupta, Goennenwein, Bausch, Sackmann, *PRE* **69**, 021901 (2004).

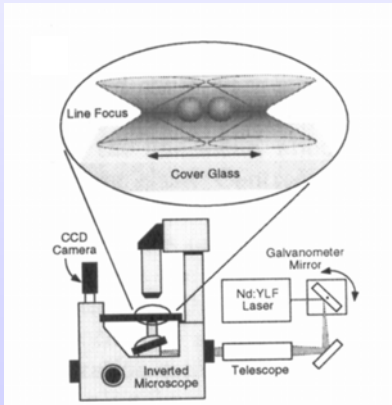

▪ Scanning optical tweezer and videomicroscopy

- Verma, Crocker, Lubensky, Yodh, *PRL* **81**, 4004 (1998).
- Crocker, Matteo, Dinsmore, Yodh, *PRL* **82**, 4352 (1999).

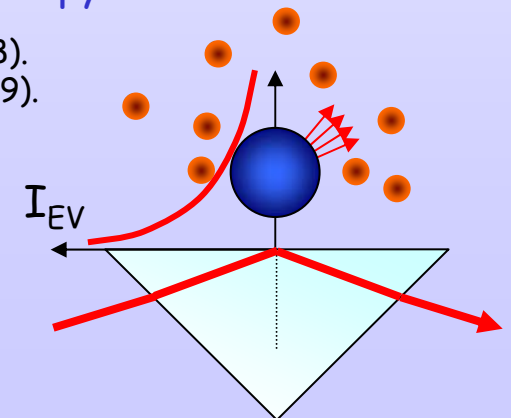

▪ Total internal reflection microscopy (TIRM)

- Walz, *Curr. Op. Coll. Interf. Sci.* **2**, 600 (1997).
- Prieve, *Adv. Coll. Interf. Sci.* **82**, 93-125 (1999).
- Bike, *Curr. Op. Coll. Interf. Sci.* **5**, 144 (2000)

Single particle evanescent light scattering

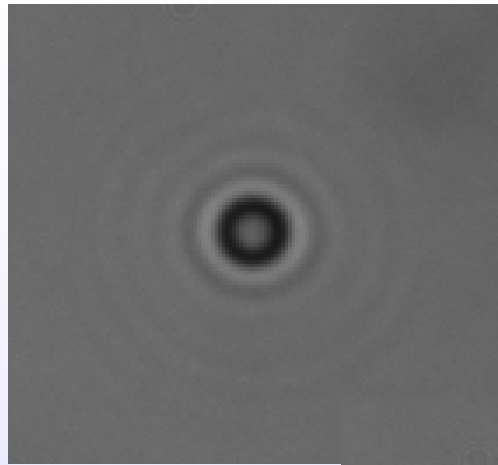

3.7 μm
Polystyrene
Particle

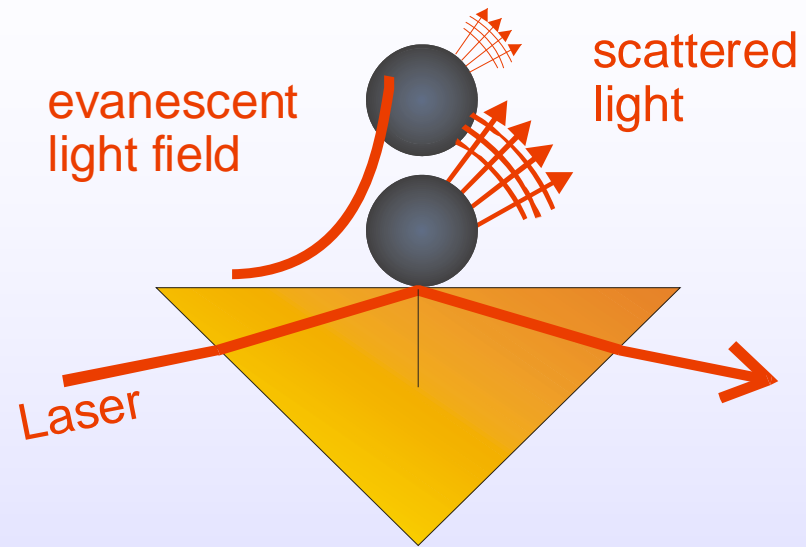
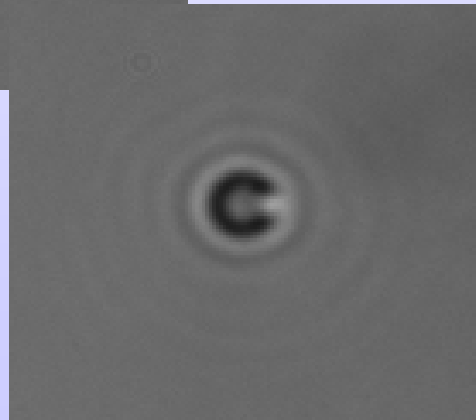
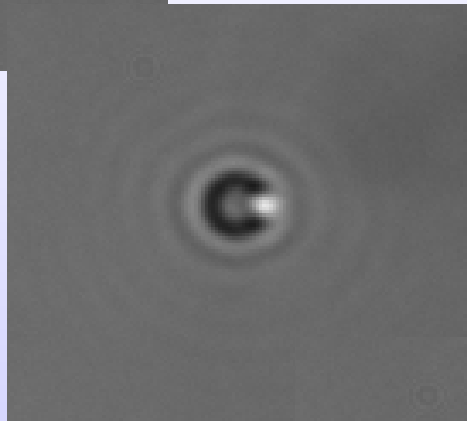

$$I_{sc} \sim I_{ev} \sim \exp\{-\beta z\}$$

Scattering intensity
 \Leftrightarrow
Particle-Wall
Distance

The TIRM-Method

TIRM: Total Internal Reflection Microscopy

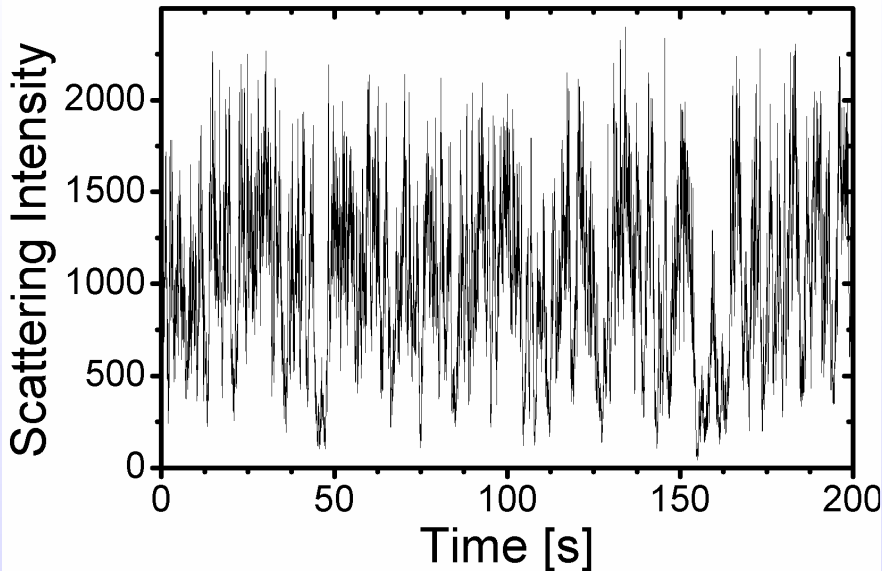

Interaction potential with femtonewton resolution!

Here: electrostatic repulsion
+ gravity

Scattering intensity reflects
Brownian motion perpendicular to
the substrate

Boltzmann-Equation:

$$P(z) = A \exp [-\Phi(z)/k_B T]$$

Probability \Leftrightarrow Potential

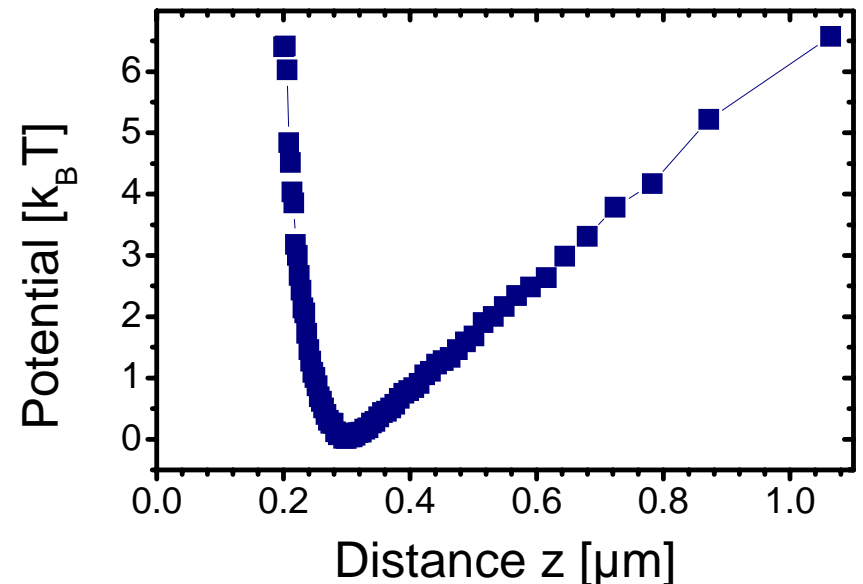

Experimental set-up

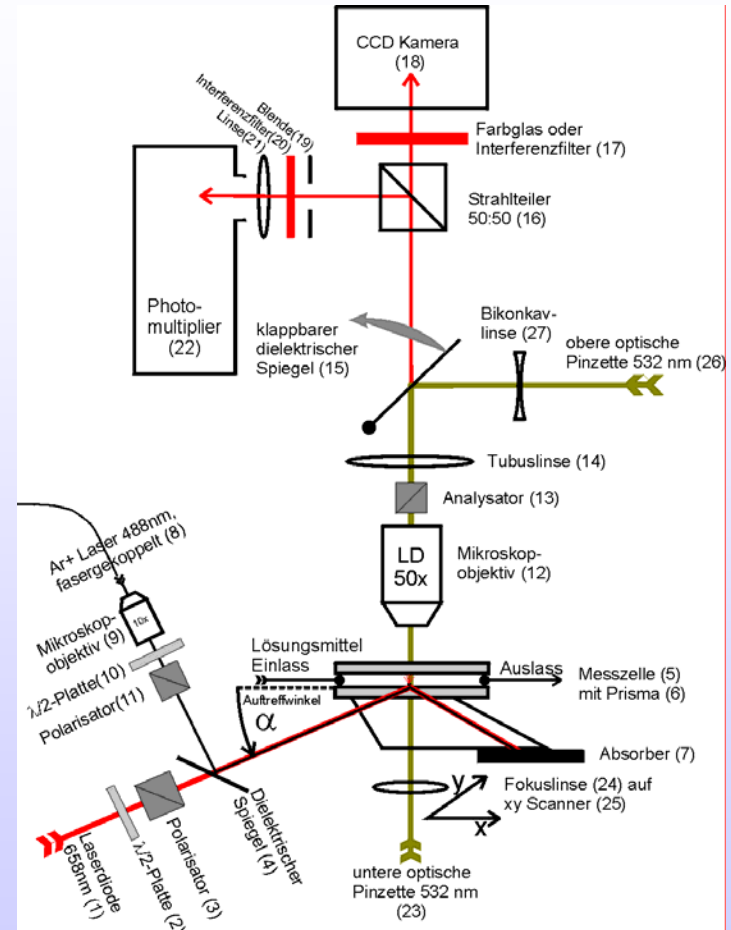
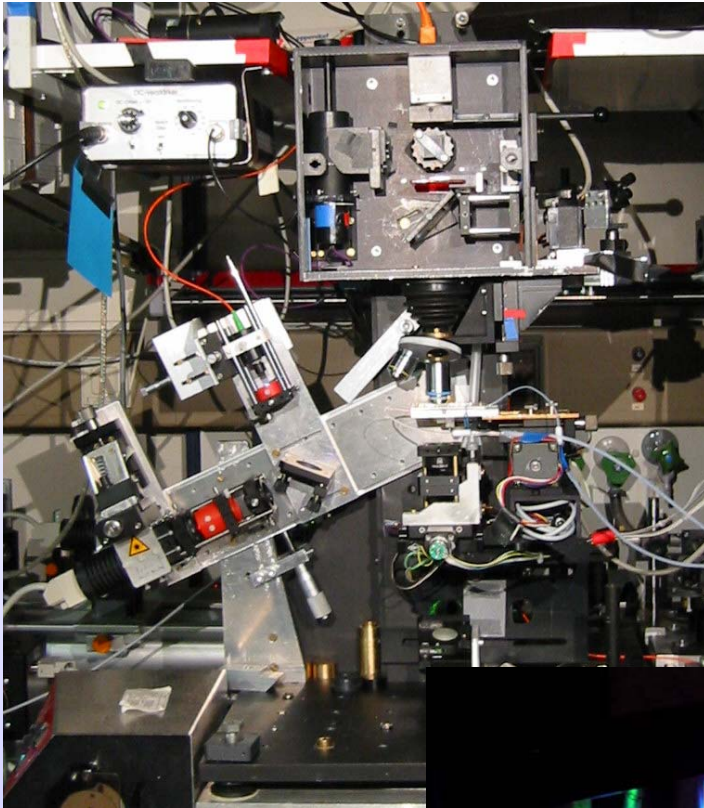

Tuning interaction potentials by light forces- Force resolution of TIRM

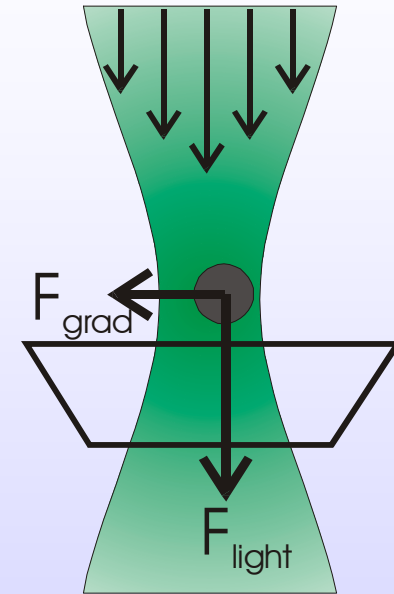
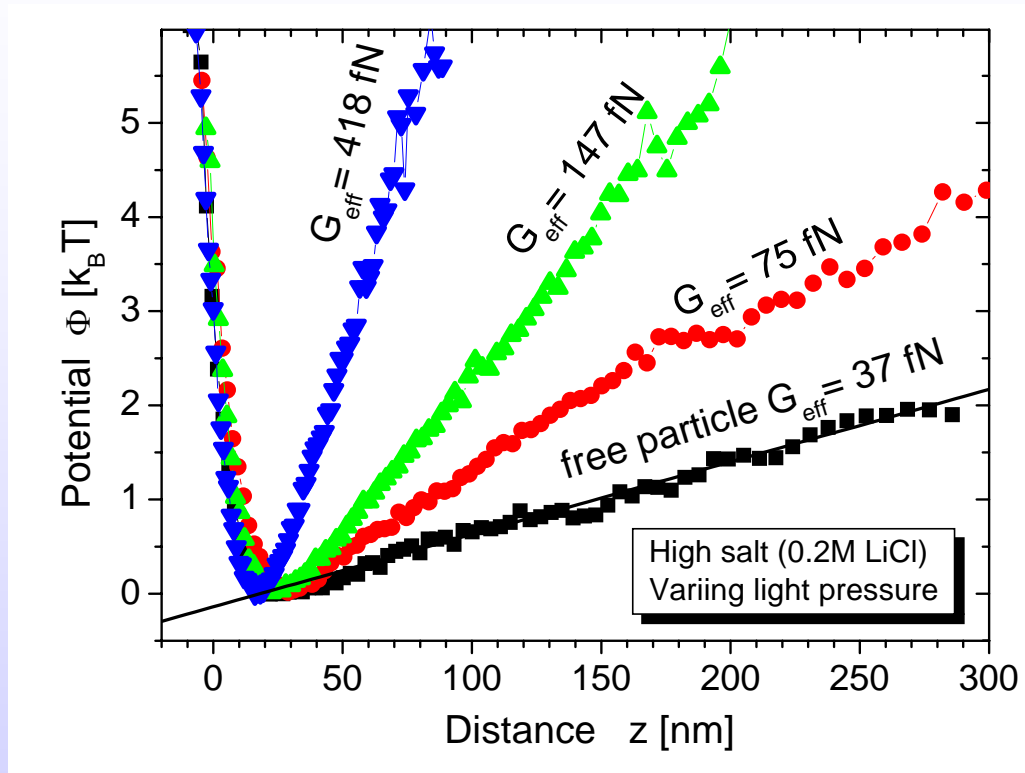

Light pressure (F_{light})

Gradient force (F_{grad})

$$\Phi(z) = B \exp(-\kappa z) + \underbrace{(G - F_{\text{Light}})}_{G_{\text{eff}}} z$$